



OM-288716C

2023-02

Description



Powered Air Purifying Respirator Blower Units

Powered Air-Purifying Respirator (PAPR) Blower Units

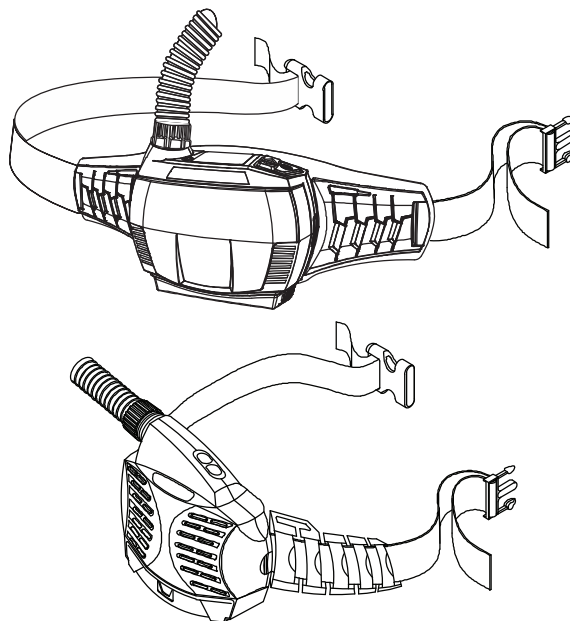

For product information,
Owner's Manual translations,
and more, visit

www.MillerWelds.com

Visit our Australian website at

www.welding.com.au

Phone 1300 300 884

Visit our New Zealand website
at

www.weldwell.co.nz

Phone 0800 9353 9355

OWNER'S MANUAL

TABLE OF CONTENTS

SECTION 1 – SAFETY PRECAUTIONS – READ BEFORE USING	1
1-1 Symbol Usage	1
1-2 Arc Welding Hazards	1
1-3 Lens Shade Selection Table	3
1-4 California Proposition 65 Warnings	3
1-5 Principal Safety Standards	3
SECTION 2 – SAFETY PRECAUTIONS – READ BEFORE USING	4
2-1 Symbol Usage	4
2-2 Hazards	4
2-3 California Proposition 65 Warnings	5
2-4 Principal Safety Standards	5
SECTION 3 – DEFINITIONS	6
3-1 Additional Safety Symbol Definitions	6
3-2 Miscellaneous Symbol Definitions	6
3-3 NIOSH Approval, Cautions, And Limitations	7
SECTION 4 – POWERED AIR PURIFYING RESPIRATOR (PAPR)	8
4-1 Respirator Specifications	8
4-2 Charging The Battery	9
4-3 Installing The Battery	9
4-4 Attaching The Breathing Tube — Welding Helmet Head Assembly	10
4-5 Installing The Air Filter	11
4-6 Operating The Controls	12
4-7 Accessing The Menu Screens	13
4-8 Testing Airflow	14
4-9 Testing Airflow Alarm	15
4-10 Installing Shoulder Strap	15
4-11 Checking Respirator Before Use	16
4-12 Putting On The Respirator	17
SECTION 5 – MAINTENANCE AND STORAGE	18
SECTION 6 – RESPIRATOR TROUBLESHOOTING	19
SECTION 7 – PARTS LIST	20
SECTION 8 – LIMITED WARRANTY	21

SECTION 1 – SAFETY PRECAUTIONS – READ BEFORE USING

 Protect yourself and others from injury—read, follow, and save these important safety precautions and operating instructions.

1-1. Symbol Usage

 **DANGER!** – Indicates a hazardous situation which, if not avoided, will result in death or serious injury. The possible hazards are shown in the adjoining symbols or explained in the text.

 Indicates a hazardous situation which, if not avoided, could result in death or serious injury. The possible hazards are shown in the adjoining symbols or explained in the text.

NOTICE – Indicates statements not related to personal injury.

 Indicates special instructions.



This group of symbols means Warning! Watch Out! ELECTRIC SHOCK, MOVING PARTS, and HOT PARTS hazards. Consult symbols and related instructions below for necessary actions to avoid these hazards.

1-2. Arc Welding Hazards

 The symbols shown below are used throughout this manual to call attention to and identify possible hazards. When you see the symbol, watch out, and follow the related instructions to avoid the hazard. The safety information given below is only a summary of the more complete safety information found in the Principal Safety Standards. Read and follow all Safety Standards.

 Only qualified persons should install, operate, maintain, and repair this equipment. A qualified person is defined as one who, by possession of a recognized degree, certificate, or professional standing, or who by extensive knowledge, training and experience, has successfully demonstrated the ability to solve or resolve problems relating to the subject matter, the work, or the project and has received safety training to recognize and avoid the hazards involved.

 During operation, keep everybody, especially children, away.



ARC RAYS can burn eyes and skin.

Arc rays from the welding process produce intense visible and invisible (ultraviolet and infrared) rays that can burn eyes and skin. Sparks fly off from the weld.

- Wear a welding helmet fitted with a proper shade of filter to protect your face and eyes when welding or watching (see ANSI Z49.1 and Z87.1 listed in Principal Safety Standards). Refer to Lens Shade Selection table in Section 1-3.
- Wear approved safety glasses with side shields under your helmet.
- Use protective screens or barriers to protect others from flash, glare, and sparks; warn others not to watch the arc.
- Wear body protection made from leather or flame-resistant clothing (FRC). Body protection includes oil-free clothing such as leather gloves, heavy shirt, cuffless trousers, high shoes, and a cap.
- Before welding, adjust the auto-darkening lens sensitivity setting to meet the application.
- Stop welding immediately if the auto-darkening lens does not darken when the arc is struck.



WELDING HELMETS do not provide unlimited eye, ear, and face protection.

Arc rays from the welding process produce intense visible and invisible (ultraviolet and infrared) rays that can burn eyes and skin. Sparks fly off from the weld.

- Use helmet for welding/cutting applications only. Do not use helmet for laser welding/cutting.
- Use impact resistant safety spectacles or goggles and ear protection at all times when using this welding helmet.
- Do not use this helmet while working with or around explosives or corrosive liquids.
- This helmet is not rated for overhead welding. Do not weld in the direct overhead position while using this helmet unless additional precautions are taken to protect yourself from arc rays, spatter, and other hazards.
- Inspect the auto-lens frequently. Immediately replace any scratched, cracked, or pitted cover lenses or auto-lenses.
- Lens and retention components must be installed as instructed in this manual to ensure compliance with ANSI Z87.1 protection standards.
- This helmet provides protection from projectiles associated with grinding, chipping, and related activities; it is not a hard hat and does not provide protection from falling objects.



NOISE can damage hearing.

Noise from some processes or equipment can damage hearing.

- Wear approved ear protection if noise level is high.

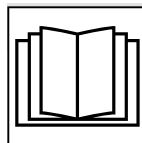

READ INSTRUCTIONS.

- Read and follow all labels and the Owner's Manual carefully before installing, operating, or servicing unit. Read the safety information at the beginning of the manual and in each section.
- Use only genuine replacement parts from the manufacturer.
- Perform installation, maintenance, and service according to the Owner's Manuals, industry standards, and national, state, and local codes.



FUMES AND GASES can be hazardous.

Welding produces fumes and gases. Breathing these fumes and gases can be hazardous to your health.

- Keep your head out of the fumes. Do not breathe the fumes.
- Ventilate the work area and/or use local forced ventilation at the arc to remove welding fumes and gases. The recommended way to determine adequate ventilation is to sample for the composition and quantity of fumes and gases to which personnel are exposed.
- If ventilation is poor, wear an approved air-supplied respirator.
- Read and understand the Safety Data Sheets (SDSs) and the manufacturer's instructions for adhesives, coatings, cleaners, consumables, coolants, degreasers, fluxes, and metals.
- Work in a confined space only if it is well ventilated, or while wearing an air-supplied respirator. Always have a trained watchperson nearby. Welding fumes and gases can displace air and lower the oxygen level causing injury or death. Be sure the breathing air is safe.
- Do not weld in locations near degreasing, cleaning, or spraying operations. The heat and rays of the arc can react with vapors to form highly toxic and irritating gases.
- Do not weld on coated metals, such as galvanized, lead, or cadmium plated steel, unless the coating is removed from the weld area, the area is well ventilated, and while wearing an air-supplied respirator. The coatings and any metals containing these elements can give off toxic fumes if welded.



BREATHING UNFILTERED AIR can be hazardous.

Welding produces fumes and gases. Misuse of the powered air purifying respirator (PAPR) may expose you to fumes and gases hazardous to your health.

- Read and follow these instructions and the safety labels carefully. The powered air purifying respirator is intended only for welding applications. The powered air purifying respirator helps protect the user from specific airborne contaminants but must be used correctly to be fully effective. Have an industrial hygienist test the air in your facility to ensure the powered air purifying respirator provides adequate protection from contaminants in your environment. If you have questions about the powered air purifying respirator, see equipment NIOSH label and consult your Safety Director and a certified Industrial Hygienist. For occupational use applications, employers must implement a written respiratory protection program meeting the requirements of OSHA 29 CFR 1910.134 (USA) or CSA Z94.4 (Canada), and other substance specific requirements as applicable.
- Do not use the powered air purifying respirator until you have been trained in its proper operation by a qualified person.
- Do not use the powered air purifying respirator in applications immediately dangerous to life or health (IDLH).
- Follow all applicable ANSI, OSHA, CSA, and other regulatory guidelines pertaining to the use of respirators.
- Do not use the powered air purifying respirator where there is danger of fire or explosion.
- Do not use the powered air purifying respirator in windy conditions or negative pressure inside the hood can draw in contaminants from the outside air.

- Do not use the powered air purifying respirator without a properly installed spark guard. Without the spark guard, welding sparks can ignite the filter or damage the filters and allow unfiltered air into the helmet.
- The powered air purifying respirator does not supply oxygen. Use the respirator only in NIOSH-approved atmospheres. Do not use the respirator where oxygen levels are 19.5% or lower, where contaminant levels are unknown or are immediately dangerous to life or health, where contaminant levels exceed the powered air purifying respirator specifications, in areas that are poorly ventilated, or where escape is not possible without using the powered air purifying respirator.
- Do not enter a hazardous area until you are sure the powered air purifying respirator is assembled correctly, working properly, and worn properly.
- Before each use, inspect the respirator equipment for damage and verify it operates properly. Before using the respirator, test air flow to verify it is providing an adequate volume of air. Clean and maintain respirator equipment according to the manufacturer's instructions.
- Do not use the powered air purifying respirator without all filter components or with the blower turned off because hazardous levels of oxygen and carbon dioxide can accumulate in the helmet.
- Always wear the powered air purifying respirator when entering a contaminated area. Do not remove the respirator until outside the contaminated area.
- Dangerous contaminants may not smell or be visible. Leave the area immediately if you notice any of the following:
 - Breathing becomes difficult.
 - You experience dizziness, impaired vision, or eye, nose, or mouth irritation.
 - The air supply smells or tastes unusual.
 - The powered air purifying respirator alarm sounds.
 - The equipment is damaged.
 - Air flow decreases or stops.
 - If you think the equipment is not supplying adequate protection.

Do not remove the equipment until you are in a safe area.

- Do not repair, modify, or disassemble the powered air purifying respirator or use with parts or accessories not supplied by the manufacturer. Use only those components that are part of the NIOSH-approved assembly.
- Replace damaged or plugged filters. Do not wash or reuse filters. Do not clean filters by tapping or with compressed air or filter elements can be damaged. Dispose of used filter elements according to local, state, and federal requirements.
- The powered air purifying respirator must be used with the helmet, hood, and filters recommended by the manufacturer to provide a NIOSH-approved respirator system. See the NIOSH label for information on the required equipment.
- Do not use the powered air purifying respirator belt and shoulder straps as a safety harness.
- Have a qualified person test the breathing air to ensure it meets Grade D requirements. Breathing air testing shall be done in accordance with a written respirator protection program (prepared by a qualified person) specific to the workplace.
- The powered air purifying respirator contains electrical parts which have not been evaluated as an ignition source in flammable or explosive atmospheres by MSHA/NIOSH.

1-3. Lens Shade Selection Table

Process	Electrode Size in. (mm)	Arc Current in Amperes	Minimum Protective Shade No.	Suggested Shade No. (Comfort)*
Shielded Metal Arc Welding (SMAW)	Less than 3/32 (2.4)	Less than 60	7	--
	3/32-5/32 (2.4-4.0)	60-160	8	10
	5/32-1/4 (4.0-6.4)	160-250	10	12
	More than 1/4 (6.4)	250-550	11	14
Gas Metal Arc Welding (GMAW) Flux Cored Arc Welding (FCAW)		Less than 60	7	--
		60-160	10	11
		160-250	10	12
Gas Tungsten Arc Welding (TIG)		250-500	10	14
		Less than 50	8	10
		50-150	8	12
Air Carbon Arc Cutting (CAC-A)	Light Heavy	150-500	10	14
		Less than 500	11	12
		500-1000	11	14
Plasma Arc Cutting (PAC)		Less than 20	4	4
		20-40	5	5
		40-60	6	6
		60-80	8	8
		80-300	8	9
		300-400	9	12
Plasma Arc Welding (PAW)		400-800	10	14
		Less than 20	6	6-8
		20-100	8	10
		100-400	10	12
		400-800	11	14

Reference: ANSI Z49.1:2021

*Start with a shade that is too dark to see the weld zone. Then, go to a lighter shade which gives a sufficient view of the weld zone without going below the minimum.

1-4. California Proposition 65 Warnings

 **WARNING – Cancer and Reproductive Harm — www.P65Warnings.ca.gov.**

1-5. Principal Safety Standards

Safety in Welding, Cutting, and Allied Processes, American Welding Society standard ANSI Standard Z49.1. Website: <http://www.aws.org>.

Safety in Welding, Cutting, and Allied Processes, CSA Standard W117.2 from Canadian Standards Association. Website: www.csagroup.org.

Safe Practice For Occupational And Educational Eye And Face Protection, ANSI Standard Z87.1, from American National Standards Institute. Website: www.ansi.org.

NIOSH Approval of Respiratory Devices, CFR Title 42 - Public Health, Part 84 from the Centers for Disease Control. Website: www.cdc.gov/niosh.

OSHA, Occupational Safety and Health Standards for General Industry, Title 29, Code of Federal Regulations (CFR), Part 1910.177 Subpart N, Part 1910 Subpart Q, and Part 1926, Subpart J. Website: www.osha.gov.

OSHA Important Note Regarding the ACGIH TLV, Policy Statement on the Uses of TLVs and BEIs. Website: www.osha.gov.

American National Standard for Respiratory Protection, ANSI /ASSE Standard Z88.2-2015 from American National Standards Institute. Website: www.ansi.org.

Selection, Use, and Care of Respirators, CAN/CSA Standard Z94.4 from Canadian Standards Association. Website: www.csagroup.org.

Commodity Specification for Air, CGA Pamphlet G-7.1 from Compressed Gas Association. Website: www.cganet.com.

Australian National Work Health Safety Policy from Safe Work Australia. Website: www.safeworkaustralia.com.

Safety in Welding and Allied Processes, AS1674.1 and AS1674.2 part 1 and 2 from SAI Global. Website: www.saiglobal.com.

PAPR-Helmet 2022-01

SECTION 2 – SAFETY PRECAUTIONS – READ BEFORE USING

 Protect yourself and others from injury—read, follow, and save these important safety precautions and operating instructions.

2-1. Symbol Usage

 **DANGER!** – Indicates a hazardous situation which, if not avoided, will result in death or serious injury. The possible hazards are shown in the adjoining symbols or explained in the text.

 Indicates a hazardous situation which, if not avoided, could result in death or serious injury. The possible hazards are shown in the adjoining symbols or explained in the text.

NOTICE – Indicates statements not related to personal injury.

 Indicates special instructions.



This group of symbols means Warning! Watch Out! ELECTRIC SHOCK, MOVING PARTS, and HOT PARTS hazards. Consult symbols and related instructions below for necessary actions to avoid these hazards.

2-2. Hazards

 The symbols shown below are used throughout this manual to call attention to and identify possible hazards. When you see the symbol, watch out, and follow the related instructions to avoid the hazard. The safety information given below is only a summary of the more complete safety information found in the Principal Safety Standards. Read and follow all Safety Standards.

 Only qualified persons should install, operate, maintain, and repair this equipment. A qualified person is defined as one who, by possession of a recognized degree, certificate, or professional standing, or who by extensive knowledge, training and experience, has successfully demonstrated the ability to solve or resolve problems relating to the subject matter, the work, or the project and has received safety training to recognize and avoid the hazards involved.

 During operation, keep everybody, especially children, away.



FIRE OR BATTERY EXPLOSION hazard.

- During operation keep everyone, especially children, away.
- Do not install or place charger on, over, or near combustible surfaces.
- Do not charge battery near flammables.
- Examine the battery before first use. Return battery to the manufacturer if battery is damaged, dirty, or emits an unusual odor.



- Use battery only with equipment with which it was supplied. Replace battery only with battery specified in Owner's Manual. Use of another battery can present a risk of fire or explosion.
- Keep battery dry.
- Do not use or store the battery in extremely hot or humid conditions. See the Owner's Manual for specific operating and storage information.
- Keep battery away from fire, out of direct sunlight, and away from other sources of heat.
- Do not use or charge the battery if it has been dropped or damaged.
- Do not open, puncture, repair, disassemble, or modify the battery.

- Charge battery only with supplied charger in an open, well-ventilated location out of direct sunlight and according to supplied instructions.
- Do not overcharge a battery or charge battery longer than specified (if charger is not equipped with automatic shutoff). See the Owner's Manual for specific information on battery charging.
- Do not charge battery by connecting directly to AC receptacle. Do not connect battery charger to automobile auxiliary power receptacle.
- Do not connect (short circuit) battery terminals to each other. Do not allow tools, conductive materials, or other objects to touch both battery terminals at the same time.
- Do not weld on battery or fasten any objects to battery.
- Do not heat battery in a microwave oven or any other heating device.
- Keep battery away from sources of high voltage.
- Do not expose battery to static electricity.
- Do not use or mix battery with damaged or worn out batteries, or other types of batteries.



BATTERY ACID can BURN SKIN and EYES.

- Replace damaged battery.
- Do not touch materials from inside a damaged battery.
- Flush eyes and skin immediately with water.

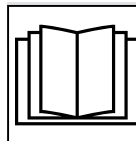

READ INSTRUCTIONS.

- Read and follow all labels and the Owner's Manual carefully before using the battery or battery charger. Read the safety information at the beginning of the manual and in each section.
- Dispose of battery according to local, state, and federal requirements. Do not dispose of battery in fire or water.
- Contact the equipment manufacturer if you have any questions about the battery.

2-3. California Proposition 65 Warnings

 **WARNING – Cancer and Reproductive Harm —** www.P65Warnings.ca.gov.

2-4. Principal Safety Standards

Safety in Welding, Cutting, and Allied Processes, American Welding Society standard ANSI Standard Z49.1. Website: <http://www.aws.org>.

Safety in Welding, Cutting, and Allied Processes, CSA Standard W117.2 from Canadian Standards Association. Website: www.csagroup.org.





Safe Practice For Occupational And Educational Eye And Face Protection, ANSI Standard Z87.1, from American National Standards Institute. Website: www.ansi.org.

Small Battery 2022–01

SECTION 3 – DEFINITIONS





3-1. Additional Safety Symbol Definitions

 Some symbols are found only on CE products.

	Warning! Watch Out! There are possible hazards as shown by the symbols.
	Accidental ingestion prevention. Keep battery away from children. Battery is harmful if swallowed.
	Do not discard product (where applicable) with general waste. Reuse or recycle Waste Electrical and Electronic Equipment (WEEE) by disposing at a designated collection facility. Contact your local recycling office or your local distributor for further information.
	Recycle.

3-2. Miscellaneous Symbol Definitions

A	Amperage
V	Voltage
Hz	Hertz
—	Negative
+	Positive
≡	Direct Current (DC)
	Class II Equipment

	Polarity Of DC Power Connector
+	Increase
—	Decrease
	Power On
	Power Off (PAPR)
	Read Owner's Manual

	Small Battery
	Indoor, Dry Location Only
	No Serviceable Parts Inside
	Low Speed
	High Speed

3-3. NIOSH Approval, Cautions, And Limitations

NIOSH Approval

The *Miller* Powered Air Purifying Respirator Blower Assembly is one component of a NIOSH approved respiratory system. Refer to the User Instructions and/or the NIOSH approval label provided with the PAPR1 or PAPR2 for a listing of components that can be used to assemble a complete NIOSH-approved respirator system, or contact Miller Service.

NIOSH Cautions And Limitations

A—Not for use in atmospheres containing less than 19.5 percent oxygen.

B—Not for use in atmospheres immediately dangerous to life or health.

C—Do not exceed maximum use concentrations established by regulatory standards.

F—Do not use powered air-purifying respirators if airflow is less than four cfm (115 lpm) for tight fitting facepieces or six cfm (170 lpm) for hoods and/or helmets.

I—Contains electrical parts which have not been evaluated as an ignition source in flammable or explosive atmospheres by MSHA/NIOSH.

J—Failure to properly use and maintain this product could result in injury or death.

L—Follow the manufacturer's User's Instructions for changing cartridges and/or filters.

M—All approved respirators shall be selected, fitted, used, and maintained in accordance with MSHA, OSHA, and other applicable regulations.

N—Never substitute, modify, add or omit parts. Use only exact replacement parts in the configuration as specified by the manufacturer.

O—Refer to User's Instructions, and/or maintenance manuals for information on use and maintenance of these respirators.

P—NIOSH does not evaluate respirators for use as surgical masks.

S—Special or critical User's Instructions and/or specific use limitations apply. Refer to User's Instructions before donning.

SECTION 4 – POWERED AIR PURIFYING RESPIRATOR (PAPR)

4-1. Respirator Specifications

⚠ This equipment helps protect the user from certain contaminants. All users must read and understand these instructions and be trained in the proper use of this equipment before using. Use this equipment according to all applicable health and safety standards. If you have questions about the type of respiratory equipment required, consult your safety director and an Industrial Hygienist.

⚠ Do not enter a hazardous area until you are sure the respirator equipment is correctly assembled, working properly, and properly worn.

The powered air-purifying respirator (PAPR) filters contaminated air and blows it into the welding helmet hood through a flexible breathing tube. The respirator system generates a positive air pressure to help prevent contaminants from entering the hood. The system must include and/or be used with the equipment listed below:

- Helmet with auto-darkening lens, hood, and headgear system
- Breathing Tube
- Blower assembly with filtration system (spark guard, foam prefilter, HEPA filter), and low battery and low air flow alarms
- Belt assembly
- Air flow indicator
- Battery charger

The respirator equipment operates at temperatures from 23° to 131° F and provides air flow of 6+ CFM (low speed) to 7.06 CFM (high speed) under normal conditions. Battery life is reduced when the unit is used in a dirty environment. If the system air flow decreases to an unsafe level, an alarm will sound, the blower vibrates, and the Danger light will flash to warn the user to immediately leave the contaminated area. Use the supplied air flow indicator to determine if the unit is supplying adequate amounts of clean air.

Size (Blower Assembly)	8.25 x 7 x 3.25 in. (210 x 178 x 76 mm)
Weight (Blower Assembly, Filters, Belt, Shoulder Straps, and Battery)	48 oz. (1362 g)
PAPR Helmet Assembly Standard	AS/NZS 1716:2012
Standard Air Filter	PAPR-P2 Filter Assembly Consisting Of A Spark Guard Screen, Foam Prefilter, And Particulate (HEPA) Filter -All Part Of The NIOSH-Approved PAPR Approved To Filter Particulate Down To 0.3 Micrometers In Size
PAPR-P2 Filter Storage Life	Refer to use by date as marked on particulate filter.
Air Flow	Low Speed: 6.18+ CFM (175+ LPM) Medium Speed: 6.89 CFM (195 LPM) High Speed: 7.59 CFM (215 LPM)
Operating Temperature	23° to 131°F (-5° to 55°C)
Storage Temperature	14° to 176°F (-10° to 80°C)
Battery Type	Rechargeable Lithium
Battery Charging Time	About Three Hours
Battery Life	500 Charges - Run Time Dependent On Air Flow Rate And Filter Load
Belt Size	28 to 55 in. (711 to 1397 mm)
Relative Humidity Of Operating Environment	<90%

4-2. Charging The Battery

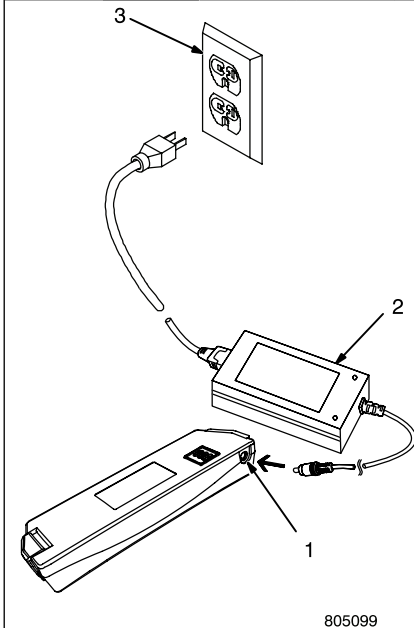
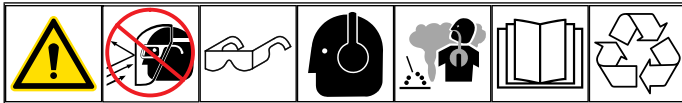

- Charge battery only with supplied charger in an open, well-ventilated location.
- Do not allow battery to get wet. Do not attempt to open the battery case.
- Keep battery away from fire or heat.
- Charge battery before first use or if battery has not been used for five days.

Dispose of battery at a designated collection facility.

Battery charging stops when battery is fully charged.

- 1 Battery Terminal
- 2 120 or 230 Volt AC Battery Charger
- 3 120 or 230 Volt AC Receptacle

Remove battery from blower assembly. Connect charger cord to battery terminal. Connect 120 volt charger to 120 volt AC receptacle (North America); connect 230 volt charger to 230 volt receptacle (EU, AUS, NZ).

The charger red light goes on when battery is being charged. When fully charged, the charger green light goes on. Charging normally takes about three hours.

If red light flashes during charging, stop charging for 30 minutes then charge battery an additional 20 minutes (green light will be on).

4-3. Installing The Battery

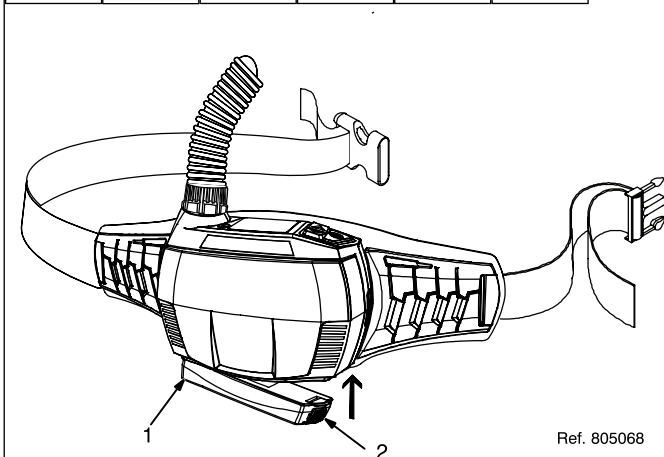
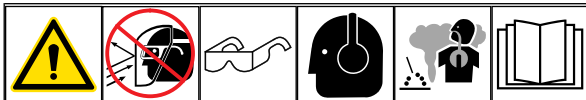

- 1 Battery
- 2 Battery Unlock Button

Place left end of battery in blower body. Push right side of battery into blower body to lock it in place.

To remove battery, push battery unlock button down and pull battery from blower assembly.

4-4. Attaching The Breathing Tube — Welding Helmet Head Assembly

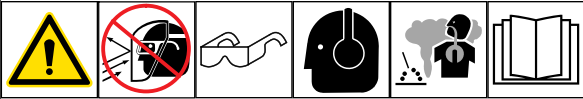

⚠ Be sure breathing tube is properly installed or contaminated air may enter the helmet.

Connecting Breathing Tube To Helmets Equipped With Tab Connector

1 Locking Tabs

While pressing blue tabs in, push breathing tube connector (rectangular end) onto helmet air inlet until breathing tube locks in position.

Connecting Breathing Tube To Blower

Align pins on breathing tube connector (blower end) with channels in blower receptacle. Insert tube connector into blower receptacle until snug and then turn connector 1/8 turn clockwise.

2 Directional Air Deflector

Adjust air direction by rotating deflectors inside the air ducts.

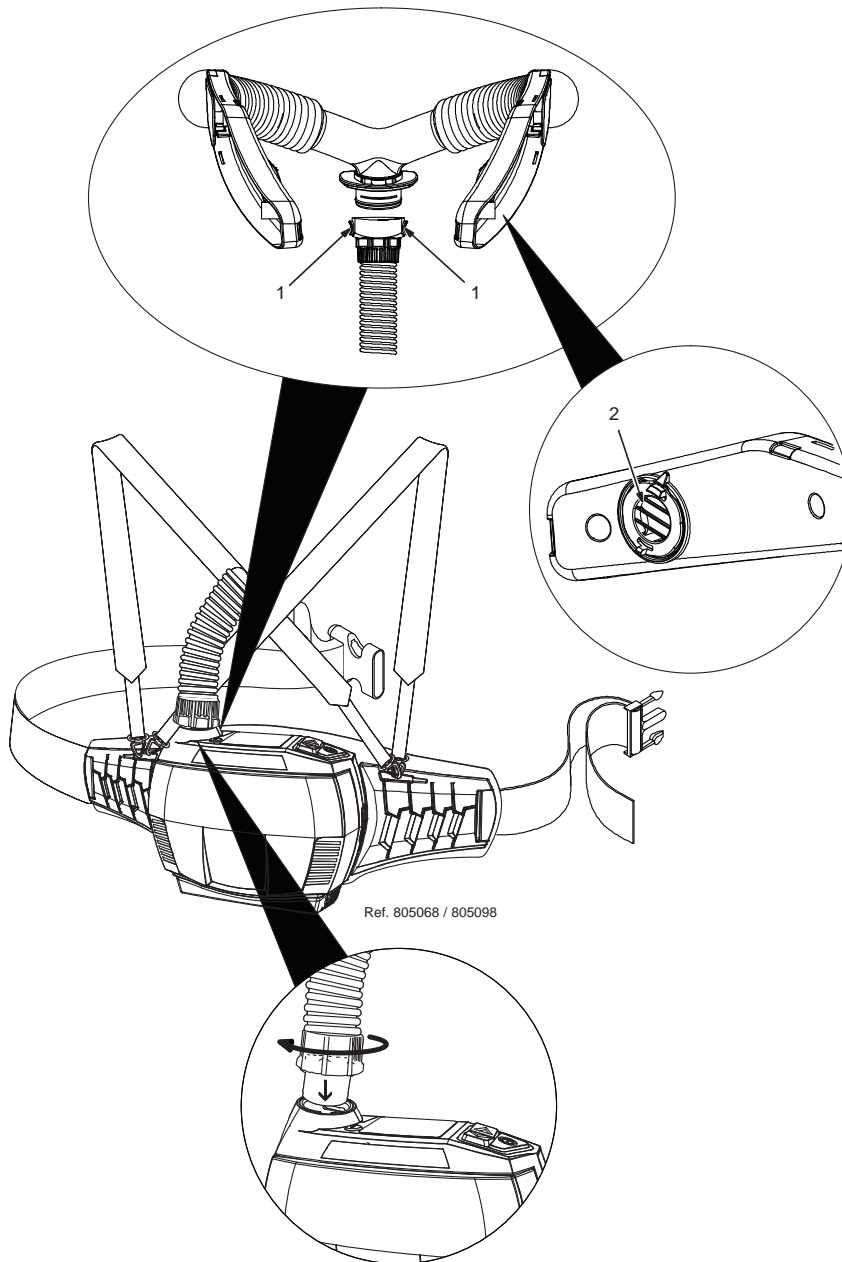

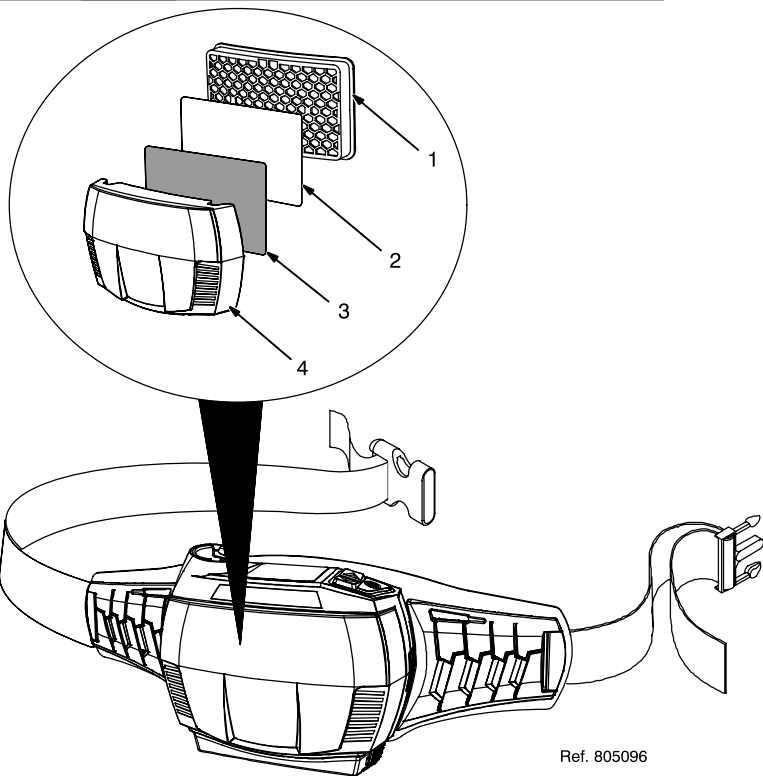
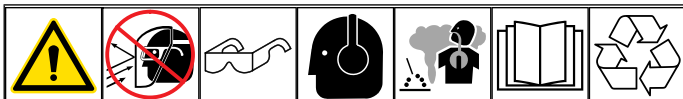

Ref. 805068 / 805098

4-5. Installing The Air Filter



 Do not use the respirator without the spark guard screen, foam pre-filter, and particulate (HEPA) filter installed.

 Replace damaged or dirty air filters. Do not wash filters, clean with compressed air, or reuse dirty air filters.

 Dispose of used filters at a designated collection facility.

- 1 Particulate (HEPA) Filter
- 2 Foam Prefilter
- 3 1 Spark Guard Screen
- 4 Cover

Install the screen, prefilter, and particulate filter in cover exactly as shown.

Install the filter assembly by sliding the tabs on the cover into the bracket on the blower body; push down on the filter until it "clicks" into position.

4-6. Operating The Controls

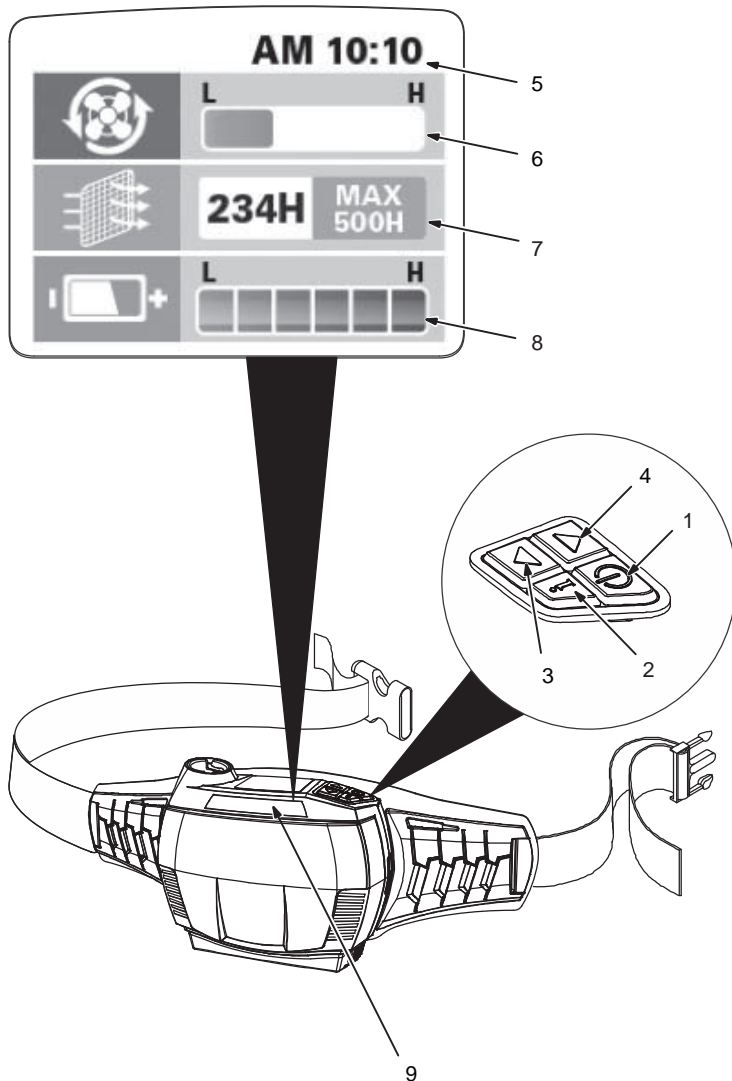
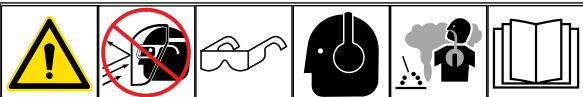

⚠ Leave the contaminated area immediately if the Danger light goes On, the alarm sounds, or the blower vibrates. Do not remove the equipment until you are in a safe area.

- 1 Power On/Off Button
- 2 Information Button
- 3 Up Navigation Button
- 4 Down Navigation Button
- 5 Clock
- 6 Fan Speed Indicator
- 7 Hour Meter
- 8 Battery Level Indicator
- 9 LED Indicator

To Start:

Press Power On/Off button for 1-2 seconds until the blower starts. The Danger indicator lights and then goes out, the alarm sounds, and the blower vibrates momentarily.

The blower always starts at the low speed. Press the Up Navigation button to switch between high, medium, and low speeds.

To Stop:

Press Power On/ Off button for 2-3 seconds until the audible alarm and blower stop.

The LED indicator flashes red, the alarm sounds, and the blower vibrates if battery power is low or air flow is reduced due to a dirty filter, blocked breathing tube, or other problem. See Troubleshooting (Section 6).

The LED indicator is green during normal operation, orange when the filter is nearing end of life, and red when the filter must be changed.

The Battery Level indicator shows the power remaining in the battery. The battery is fully charged when the indicator bar is full (H).

4-7. Accessing The Menu Screens

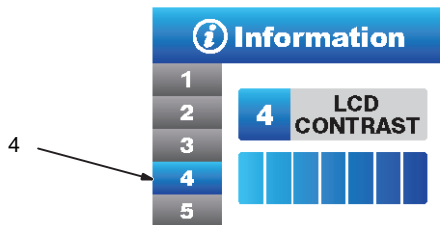
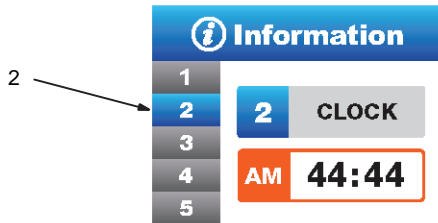
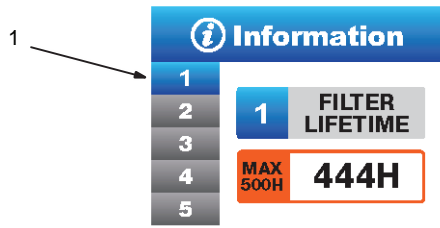
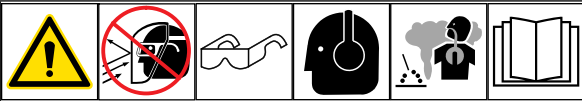

⚠ Leave the contaminated area immediately if the Danger light goes On, the alarm sounds, or the blower vibrates. Do not remove the equipment until you are in a safe area.

Press the Information button to access the menu. The Information menu provides the user with access to five different settings screens. Use the Up/Down Navigation buttons to scroll through the screens.

1 Filter Lifetime

The Filter Lifetime screen displays the number of hours since the last reset. To reset the Filter Lifetime hour meter, navigate to screen 1 and press the Information button. Press the Power On/Off button to confirm.

The hour meter cannot be set higher than 500 hours.

2 Clock

The Clock screen displays the current time. To set the clock, navigate to screen 2. Press the Information button and use the Up and Down buttons to change the hour. Press the Information button again to select minutes. Use the Up and Down buttons to change the minutes value. Press the Information button to confirm.

3 External LED

The External LED screen indicates the status of the LEDs on the outside of the blower. To change this setting, navigate to screen 3. Press the Information button to change the LED setting. Press the Power On/Off button to confirm.

4 LCD Contrast

The LCD Contrast screen indicates the current LCD contrast setting. To change the contrast setting, navigate to screen 4 and use the Information button to cycle through the contrast levels. After selecting a contrast level, press the Power On/Off button to confirm.

5 View Angle

The View Angle screen displays the current orientation of the on-screen menu. To change the View Angle, navigate to screen 5 and press the Information button. Press the Power On/Off button to confirm.

4-8. Testing Airflow

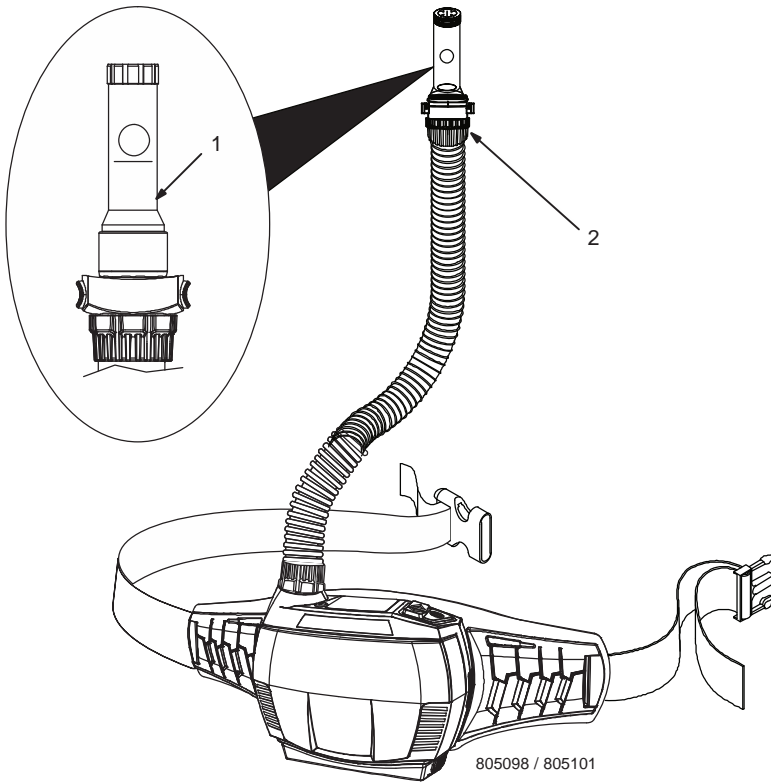
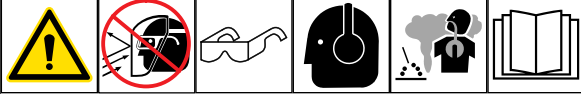

⚠ Always test air flow before using the respirator. Also check air flow each month if respirator is not used regularly.

- 1 Flowmeter
- 2 Breathing Tube Connector (Hood)

Disconnect breathing tube from hood. Insert flowmeter into breathing tube. Be sure breathing tube is straight and untwisted. Hold flowmeter straight up and start blower.

Air flow is adequate if flowmeter ball moves above MIN mark. Do not use respirator if flowmeter reads MIN or below. If air flow is low, check battery and filter elements, and recheck air flow.

4-9. Testing Airflow Alarm

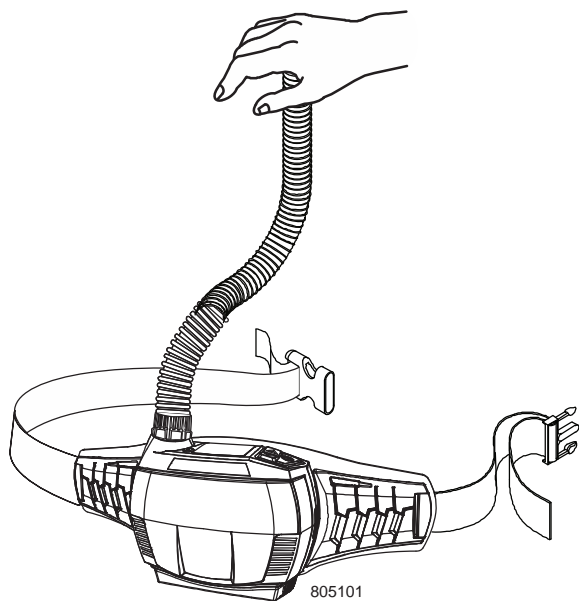
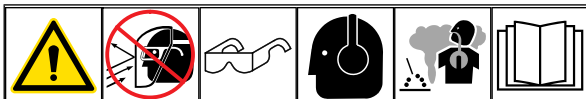

⚠ Always test air flow alarm before using the respirator. Also check air flow alarm each month if respirator is not used regularly.

Disconnect breathing tube from hood. Start blower and block air flow by placing your hand over the end of the breathing tube. Continue blocking air flow until alarm sounds and the blower vibrates (about 15 to 20 seconds).

If alarm does not sound and the blower does not vibrate, check battery and filter element.

4-10. Installing Shoulder Strap

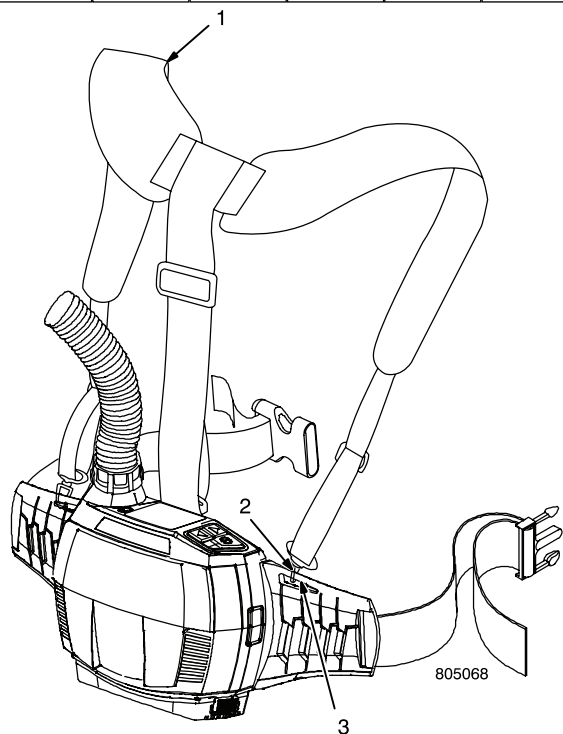
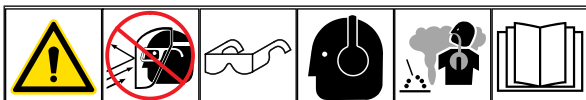

- 1 Shoulder Strap
- 2 Snap
- 3 Link

Connect snaps on shoulder straps to links on belt.

4-11. Checking Respirator Before Use

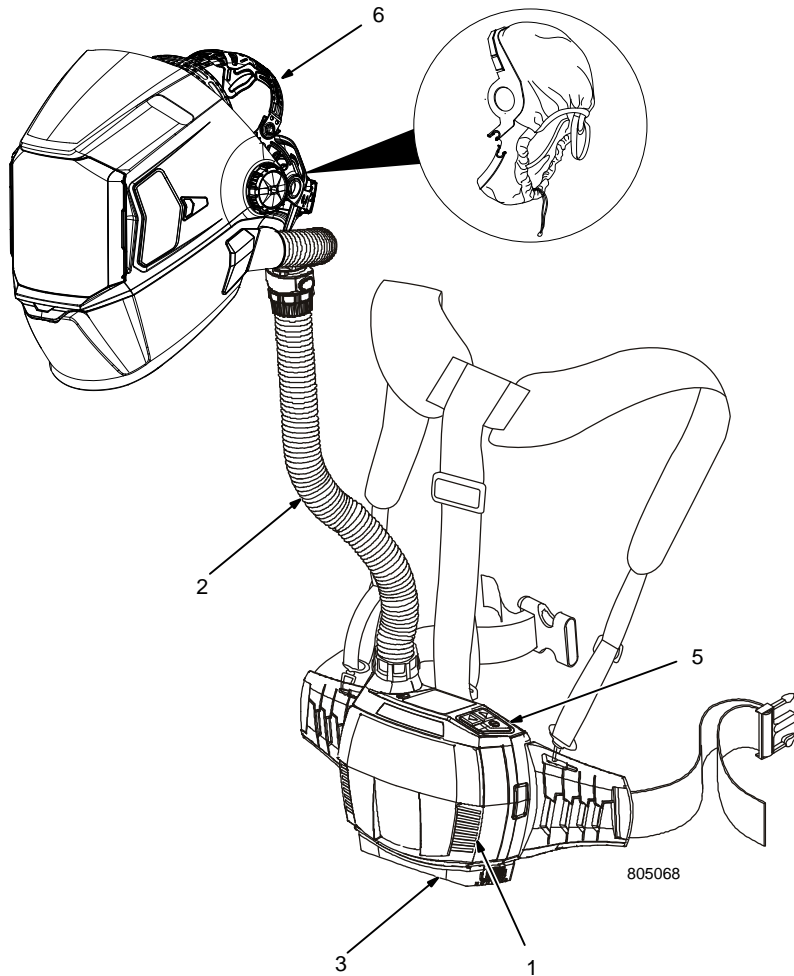
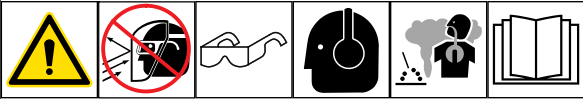

Before using the respirator, check the following items:

1 Air Filter Assembly

Verify the air filter is suitable for the application and is NIOSH-approved. Also be sure the filter is undamaged, properly assembled, and securely connected to the blower assembly.

2 Breathing Tube

Be sure the tube is undamaged and properly connected to the blower assembly and hood.

3 Battery

Verify the battery is fully charged and securely connected to the blower assembly.

4 Air Flow (Not Shown)

Test air flow according to Section 4-8.

5 Airflow Alarm

Turn on blower assembly and check for audible, visual, and vibratory alarms (see Sections 4-6 and 4-9). See Troubleshooting section if alarms go on at any other time (Section 6).

6 Hood

Inspect the hood and replace if damaged. See Troubleshooting (Section 6) if air is not being supplied to hood.

4-12. Putting On The Respirator

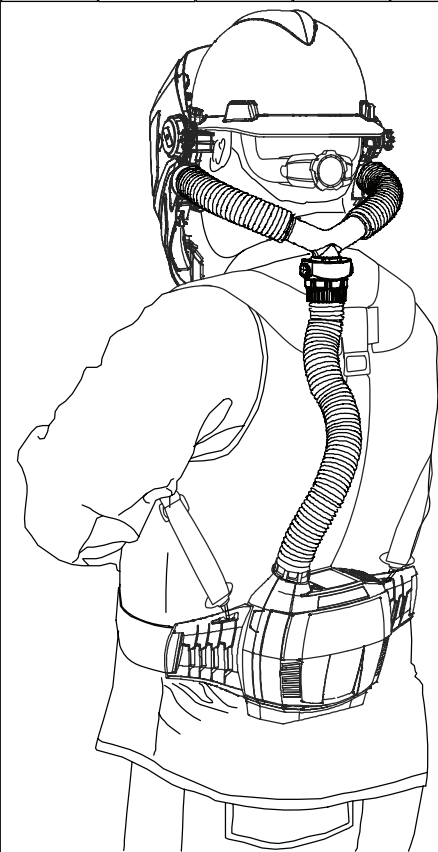
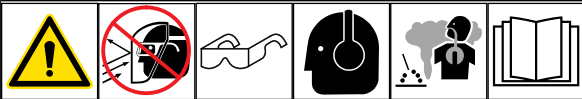

805187

 Do not enter a hazardous area until you are sure the respirator equipment is correctly assembled, working properly, and properly worn.



 Leave the contaminated area immediately if the Danger light goes On, the alarm sounds, or the blower vibrates. Do not remove the equipment until you are in a safe area.

 See Parts List in Section 7 for optional belt extension.

Place blower assembly against lower back with breathing tube extending upwards. Slide straps over shoulders and fasten belt around waist. Adjust straps and belt so unit rests comfortably against lower back.

Put on head assembly. Adjust head assembly to fit snugly on head. Tighten hood drawstring (if equipped) to establish a tight seal around head.

SECTION 5 – MAINTENANCE AND STORAGE

-  **Replace damaged or dirty air filters. Do not wash filters, clean with compressed air, or reuse dirty air filters.**
-  **Never use solvents or abrasive cleaning solutions to clean the respirator. Keep water and other fluids out of blower assembly.**

 *Maintain accurate records of filter replacement and respirator maintenance.*

For best performance clean the equipment after each use. Use a soft cloth dampened with a mild soap and water solution to wipe all external surfaces clean. Allow to air dry.

Product usage, workplace contamination levels, and other factors affect the life of the filter elements. Replace filter elements if air flow is reduced due to a dirty filter and according to the filter change schedule established by your Safety Director and an Industrial Hygienist.

Inspect breathing tube and replace if damaged or if inside of tube is dirty.

If the respirator will not be used for an extended period, remove the filter and battery and store them in a clean, dry, cool place free of solvent-based vapors.

End Of Useful Life

The respirator has no expiration date, and with proper care and maintenance it can provide many years of respiratory protection. The respirator can continue to be used, provided that all components are undamaged (no cracks, gaps, holes, or air leaks) and the blower functions normally (supplies sufficient air to hood).

SECTION 6 – RESPIRATOR TROUBLESHOOTING

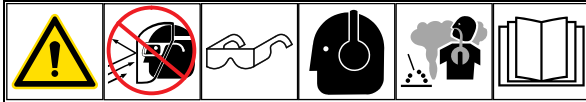

Trouble	Remedy
Blower does not supply air to hood.	Press On button.
	Dead battery; recharge battery (see Section 4-2).
	Verify battery is properly connected to blower body.
	Remove blockage from blower outlet and breathing tube.
Blower cannot be turned Off.	Press Off button for two to three seconds.
Blower runs for short time even though battery is fully charged.	Be sure battery is properly connected to battery charger.
	Replace battery.
	Replace charger.
Battery warning light is On and alarm sounds.	Continue wearing the respirator and leave the contaminated area immediately. Charge or replace the battery. The blower will operate for about 20 minutes after the warning light goes on.
	Have Safety Director and an Industrial Hygienist determine if you are using the proper equipment for the work environment.
Battery run time is too short.	Replace battery.
	Check air filter and replace if necessary (see Sections 4-5 and 4-11). A clogged air filter element reduces battery life.
Battery charger does not connect to battery.	Verify the correct battery charger is being used:
	Use charger 244132 for battery 244131.
	Use charger 282077 for battery 287178.
Danger light is On, alarm sounds or blower vibrates.	Continue wearing the respirator and leave the contaminated area immediately. Check blower air flow (see Sections 4-5 and 4-11).
	Remove blockage from blower outlet and/or breathing tube. If alarm sounds or blower vibrates continuously, contact a Factory Authorized Service Agent.
	Remove packaging from air filter.
	Have Safety Director and an Industrial Hygienist determine if you are using the proper equipment for the work environment.
Air supplied to hood smells and tastes unusual; eyes and throat irritation.	Continue wearing the respirator and leave the contaminated area immediately. Check contamination level of filter, and replace filter if necessary.
	Check breathing tube connections to blower and hood.
	Verify spark guard, prefilter, and particulate (HEPA) filter are installed in blower assembly.
	Have Safety Director and an Industrial Hygienist determine if you are using the proper equipment for the work environment.
Blower supplies insufficient air to hood.	Check breathing tube connections to blower and hood.
	Remove blockage from blower outlet and/or breathing tube.
	Check air filter and replace if necessary (see Sections 4-5 and 4-11). A clogged air filter element reduces battery life.

SECTION 7 – PARTS LIST

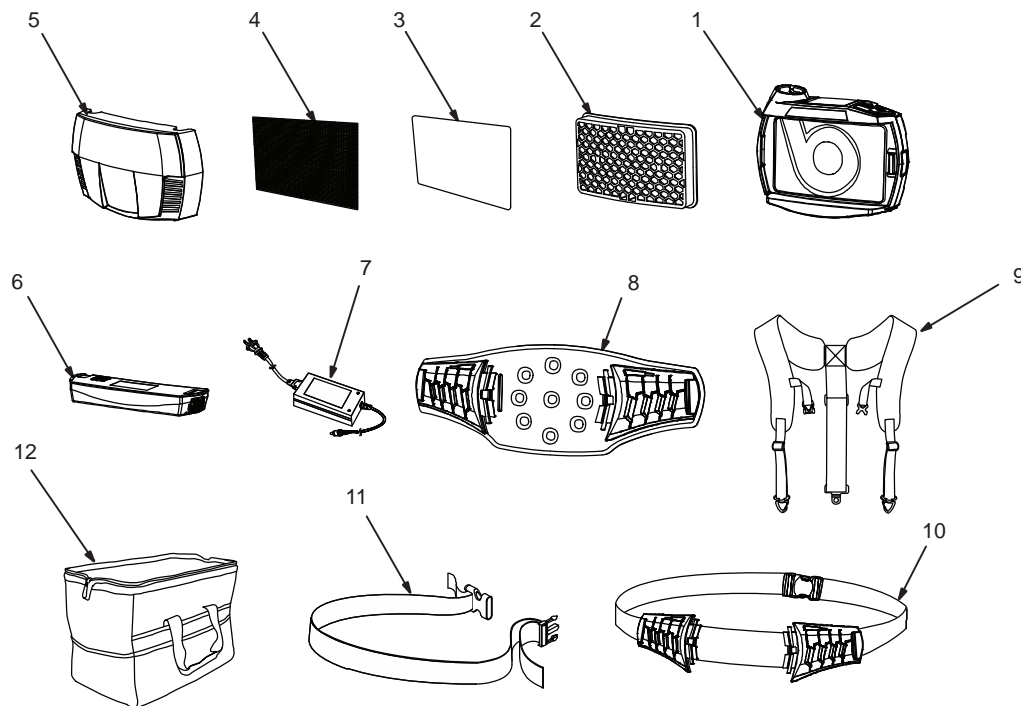

Figure 7-1. Powered Air Purifying Respirator (PAPR) Blower Assembly

Powered Air Purifying Respirator (PAPR) Blower Assembly

Item No.	Dia. Mkgs.	Part No.	Description	Quantity
1		287172	Blower Assembly (Includes)	1
		272668	— Label, Warning Supplied Air Respirator	1
2		287170-2	Filter, Particulate (HEPA) (2-Pack)	1
		287170-6	Filter, Particulate (HEPA) (6-Pack)	1
		287170-36	Filter, Particulate (HEPA) (36-Pack)	1
3		235674	Filter, Prefilter (Foam)	1
		◆268841	Filter, Prefilter Nuisance Level OV Relief (Not Shown)	1
4		235676	Spark Guard	1
5		287175	Filter Cover	1
6		287178	Battery, Blower, 14.8V, 3A (Use With Charger 282077)	1
7		282077	Charger, 16.8V, 2A (Use With Battery 287178)	1
8		288941	Belt Pad (PAPR)	1
9		287177	Shoulder Straps	1
10		◆287176	Belt	1
10		◆264582	Belt, Leather	1
11		244151	Belt Extension	1
12		228028	Bag	1

◆ Optional

SECTION 8 – LIMITED WARRANTY

LIMITED WARRANTY (AUSTRALIA)

Welding Industries of Australia (WIA) warrants to the original retail purchaser that the Miller Power Air-Purifying Respirator (PAPR) Blower Unit purchased (Product) will be free from defects in materials and workmanship for a period of 1 years from the date of purchase of the Product by the customer. If a defect in material or workmanship becomes evident during that period, Welding Industries of Australia will, at its option, either:

- Repair the Product (or pay for the costs of repair of the Product); or
- Replace the Product.

In the event of such a defect, the customer should return the Product to the original place of purchase, with proof of purchase, or contact Welding Industries of Australia on 1300 300 884.

Any handling and transportation costs (and other expenses) incurred in claiming under this warranty are not covered by this warranty and will not be borne by Welding Industries of Australia. Welding Industries of Australia will return the replacement Product (if found faulty) or the original Product (if not faulty) freight free to the customer.

This warranty covers the PAPR blower unit only, and does not extend to the breathing tube, padded belt or accessories included in the original purchase package.

The obligation of Welding Industries of Australia under this warranty is limited to the circumstances set out above and is subject to:

- The customer being able to evidence the acquisition of the Product, the purchase price paid for the Product and the relevant defect in materials or workmanship;
- The Product not having been altered, tampered with or otherwise dealt with by any person in a manner other than as intended in respect of the relevant Product; and
- The Product not having been used or applied in a manner that is contrary to customary usage or application for the relevant Product or contrary to any stated instructions or specification of Welding Industries of Australia.

Our goods come with guarantees that cannot be excluded under the Australian Consumer Law. You are entitled to a replacement or refund for a major failure and for compensation for any other reasonably foreseeable loss or damage. You are also entitled to have the goods repaired or replaced if the goods fail to be of acceptable quality and the failure does not amount to a major failure. The benefits given by this warranty are in addition to other rights and remedies which may be available to the customer under any law in relation to goods and services to which this warranty relates.

Warranty provided by:

Welding Industries of Australia (ABN 63 004 235 063)

A Division of ITW Australia Pty Ltd

5 Allan Street, Melrose Park, South Australia, 5039

Ph. 1300 300 884

Email: info@welding.com.au

Web: www.welding.com.au

LIMITED WARRANTY (NEW ZEALAND)

Weldwell warrants to the original retail purchaser that the Miller Auto-Darkening Power Air-Purifying Respirator (PAPR) Blower Unit purchased (Product) will be free from defects in materials and workmanship for a period of 1 years from the date of purchase of the Product by the customer. If a defect in material or workmanship becomes evident during that period, Weldwell will, at its option, either:

- Repair the Product (or pay for the costs of repair of the Product); or
- Replace the Product.

In the event of such a defect, the customer should return the Product to the original place of purchase, with proof of purchase, or contact Weldwell on 06 834 1600.

Any handling and transportation costs (and other expenses) incurred in claiming under this warranty are not covered by this warranty and will not be borne by Weldwell. Weldwell will return the replacement Product (if found faulty) or the original Product (if not faulty) freight free to the customer.

This warranty covers the PAPR blower unit only, and does not extend to the breathing tube, padded belt or accessories included in the original purchase package.

The obligation of Weldwell under this warranty is limited to the circumstances set out above and is subject to:

- The customer being able to evidence the acquisition of the Product, the purchase price paid for the Product and the relevant defect in materials or workmanship;
- The Product not having been altered, tampered with or otherwise dealt with by any person in a manner other than as intended in respect of the relevant Product; and
- The Product not having been used or applied in a manner that is contrary to customary usage or application for the relevant Product or contrary to any stated instructions or specification of Weldwell.

Our goods come with guarantees that cannot be excluded under the New Zealand Consumer Guarantees Act. You are entitled to a replacement or refund for a major failure and for compensation for any other reasonably foreseeable loss or damage. You are also entitled to have the goods repaired or replaced if the goods fail to be of acceptable quality and the failure does not amount to a major failure. The benefits given by this warranty are in addition to other rights and remedies which may be available to the customer under any law in relation to goods and services to which this warranty relates.

Warranty provided by:

Weldwell (NZBN 9429039833129)

A Division of the ITW Welding Group

64 Thames Street, Napier 4110

Ph. 0800 WELDWELL

Email: info@weldwell.co.nz

Web: www.weldwell.co.nz

Miller Electric Mfg. LLC

An Illinois Tool Works Company
1635 West Spencer Street
Appleton, WI 54914 USA

USA Phone: 920-735-4505
Australia Phone: 1300 300 884
New Zealand Phone: 0800 9353 9355

www.welding.com.au
www.weldwell.co.nz

